

Fence Elevation

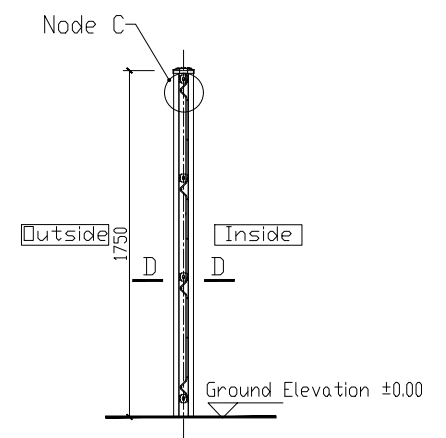

A-A Sectional

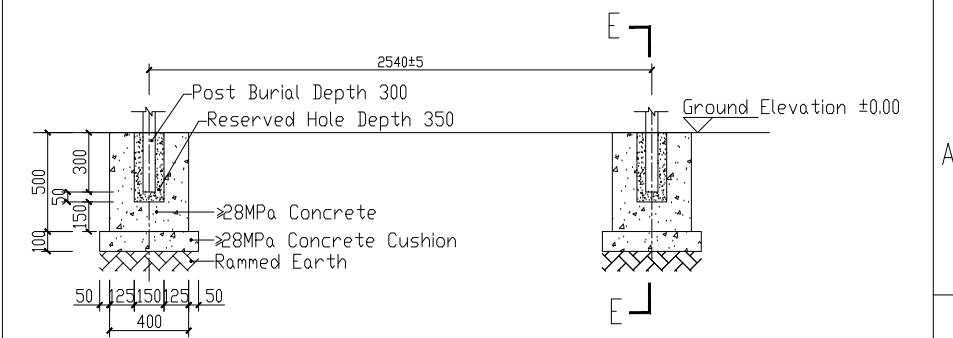

Foundation Elevation



Foundation Plan

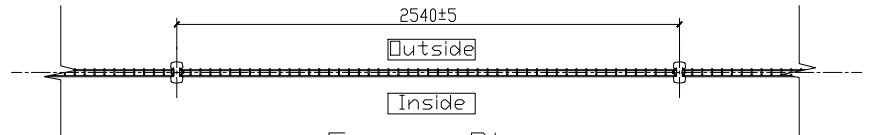

Fence Plan

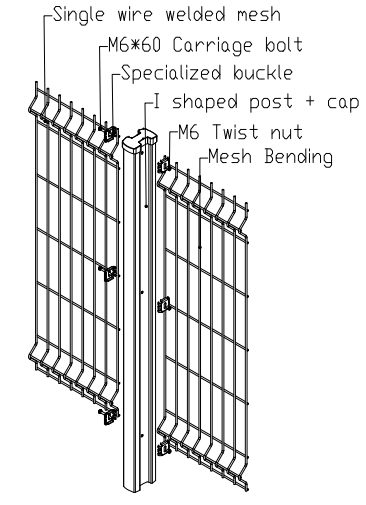

Fence Perspective

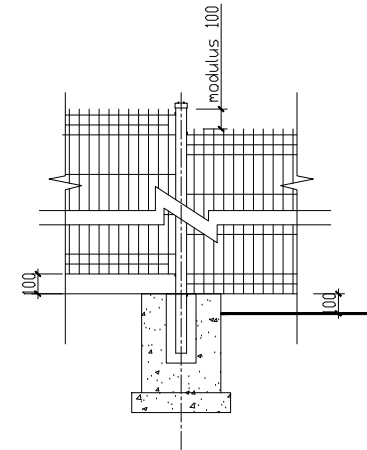

Ladder Node

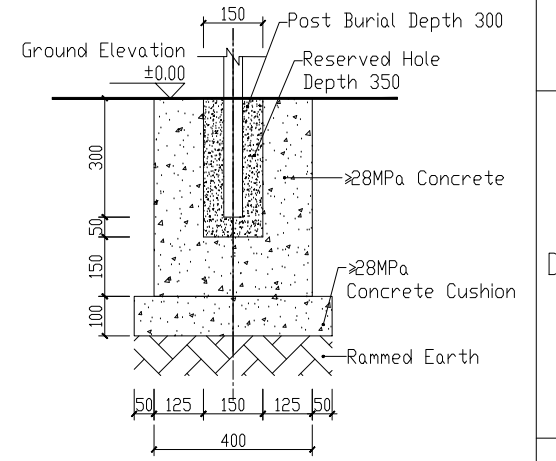

E-E Sectional 2:1

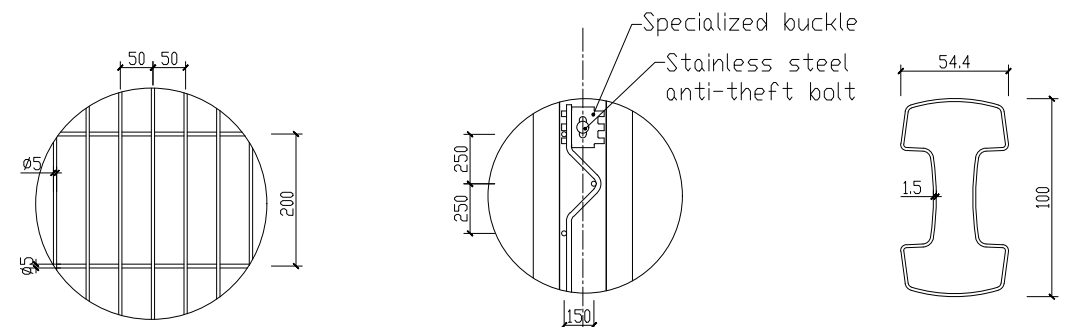

Node B 4:1

Node C 5:1

D-D 10:1

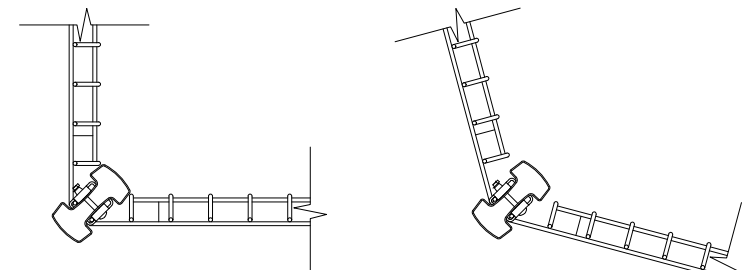

Corner Node

Technical Description:
 1.The dimensions marked in the figure are the centerline dimensions, measured in millimeters;
 2.The installation height of the fence is 1730 (excluding the foundation), and the center distance of the columns is 2540 ± 5;
 3.The fence is composed of directly buried columns (including top cover), connectors, mesh and other components;
 4.The column adopts "I-shaped" straight seam welded pipe, made of continuous hot-dip galvanized steel plate, Q235 material, with a galvanizing amount of ≥ 120g/m² (double-sided);
 5.The cross-sectional size of the column is 54.4 x 100 x 1.5, with a height of 2050;
 6.The mesh is made of high-strength cold drawn hot-dip galvanized steel wire resistance welding, with steel wire material Q195, steel wire tensile strength ≥ 450MPa, steel wire diameter of $\phi 5$ (horizontal wire)+ $\phi 5$ (vertical wire), and galvanizing amount ≥ 120g/m²;
 7.The height of the mesh is 1630, the width is 2500, the grid is 50 (vertical wires) x 200 (horizontal wires), and the reinforcement groove is 50 (vertical wires) x 50 (horizontal wires);
 8.The surface of the columns and mesh is coated with high adhesion thermosetting polyester powder electrostatic coating, with a coating thickness of ≥ 100 μ m, coating adhesion ≥ 0 level, coating gloss 80-95°, photo aging ≥ 0 level, and weather resistance ≥ 5;
 9.The fence foundation is made of ≥ 28MPa concrete cast-in-place (can be prefabricated), with 150 x 150 x 350 column embedding holes reserved. After the columns are embedded, they are fixed by secondary pouring at a depth of 300;

COLLIAND

Project Name:		Project No.	
Building Name:		Drawing Phase	
Drawing Title: PXN&GP-1730 Fence construction drawing		Drawing No.	
		Scale	
		Version	
		Date	

Drawn by		Verified by	
Designed by		Examined by	
Checked by		Project Principal	

Former outline drawing Number
 Outline drawing Number
 Signature
 Date